

EDP-C2

***ELECTRONIC CONTROLLER
CONTRÔLEUR ÉLECTRONIQUE***

EDP CONCEPTION

EDPCONCEPTION.COM

Table of Contents

Introduction	page 3
Installation	page 4
Controller Properties	page 5
System Hook-up Diagram	page 7
Programming	page 8
Fuse Replacement	page 10
Generator connection	page 11
Conductor Size and Fuse Notification	page 12
Pulley Size	page 13
Number of Belts to Use	page 14
Alarm Display	page 14
Message	page 15
Trouble Shooting	page 16
Signalling Indicators Description	page 17
Warranty	page 18
Security Warning	page 20
Value Notification Table	page 21

Introduction

- **EDP-C2** consists of a complete electronic concept which allows a greater control of the working parameters resulting in increasing the lifespan of the generator and the electromagnet.
- The controller is easy to install. It only needs a few connections and it is pre programmed and ready to use.
- The controller adapts to most generators (within a range of 180 volts DC to 300 volts DC of range with a maximum of 5 amps) on field.
- The amperage of the electromagnet does not affect the controller.
- The system tolerates + - 10% of generator RPM without affecting the efficiency, which is very useful for the systems that use hydraulic driven generators.
- The controller`s display shows the voltage and the amperage applied to the electromagnet.
- The controller also shows the modulation and the voltage applied to the field signal.
- The information displayed by the controller will allow us to guide you in the adjustments at a distance, to increase the efficiency or to help fix your lifting equipment.

INSTALLATION

For new installation see page 13

For existing installations no pulley calculations are required

Important notice: The installation must be carried out by qualified personnel, voltages can reach 400VDC. Installation must be of professional quality.

The input and output can not be connected to excavator because the controller is isolated from the battery he have an isolator inside be sure to ,follow the connection diagram.

- 1- Fix the main casing to a solid surface.
- 2- Before drilling holes in main casing, unscrew the four corner bottom plate screws so to protect the controller unit.
- 3- Make wires pass through the bottom of the casing in a way to prevent water break through.
- 4- Refer to the Installation Diagram (P7) and hook-up exactly as illustrated. Re-verify hook-up.
- 5- Do not close the generator`s connection box for there is a possibility that F1 and F2 or F1 and F4 need to be reversed. If you have to respect color wire.
- 6- Turn the ignition key to power up the controller without activating the generator. Note: the controller must stay activated during the start up procedure to insure a good start up; that is why it is connected to ignition.
- 7- The controller can display the actual isolation of electromagnetic system .
This message is for information only push right arrow. Now you can select the next Isolation value with up and down arrow. If the isolation go under the selected value An alarm appear only for inform you the evolution of system isolation . The system still working.
- 8- It is now time to program the system according to your system requirements; the default settings are for an electromagnet of 230VDC. Refer to page 9.
- 9- Start the engine!
- 10- Adjust throttle to a maximum to maintain a good hydraulic pressure.
- 11- Activate the command button or the upper arrow to engage magnetism.
- 12- Observe the activity on the display, volts, amps, modulation field volts.
- 13- This step should be made with a cold magnet to have a best amp in autoajustement .
Push on command switch or on up arrow to load and still the control switch on and wait NEW SET UP message appears and release switch .
The controller will automatically adjust the magnetisation in respect to the volt parameter He can change many parameter identified by (*).
The same parameter can be change manually after.

To improve efficiency fill out the Value Notification Table at the end of the manual (p21) and call a technician (many parameters are to be taken into consideration).

For more information you may call us at 1-866-535-6686

Controller Properties

- The **EDP-C2** is activated with 24v manual command instead of traditional 230v therefore making it safer for the operator. He have is own control voltage.
- If the electromagnet wires disconnect the controller will automatically lower the voltage close to 0 VDC within less than 0.5 seconds to help protection of both operator and equipment.
- The controller will activate the field current only when needed to prevent premature wear of the generator.
- The controller offers the possibility of augmenting electromagnetic efficiency by having two power levels.
 1. One called ``High Tension`` which can generate up to 30% more voltage than the standard electromagnet voltage during a predetermined time (3-10 seconds) permitting to pick up more material at a time.
 2. The other called ``Transport Tension`` which is about 15% less voltage than the standard electromagnet voltage. This tension is used to carry objects that have already been lifted thus keeping the electromagnet cooler.
- The demagnetisation is done by polarity inversion. A first dopping voltage is applied and followed by a second cleaning Voltage.
This two voltage are controlled parameter for each .
- The controller may provide two dropping modes and two Loading modes (see next page).

Working with the Controller

Manual Drop with one button mode

- 1- Press briefly on the command button for less than 0.5 seconds and the controller will activate the electromagnet.
- 2- Each time that you briefly apply the command button, the controller will reactivate the High Tension for a time determined by the parameter ``T-High Tension''.
- 3- To drop the metal, hold the command button again for more than 0.5 seconds.
- 4-

Manual Drop with two button mode

Press on the second button it will be connected to (TB IN) . It was be programmed for dropping (NO or NC) with code 72. (NO) is more safe. This parameter will deactivates the single button mode.

Auto Drop one button mode

Hold the command button for more than 0.5 seconds; as soon as the button is released the metal will drop.

Sorting

Press on the command button for more than 0.5 seconds then drop momentarily for more than 0.5 seconds. This coordination will made a quick release and grasp of the materials. You can repeat this step with a longer release and as often as you want without overheating the controller.

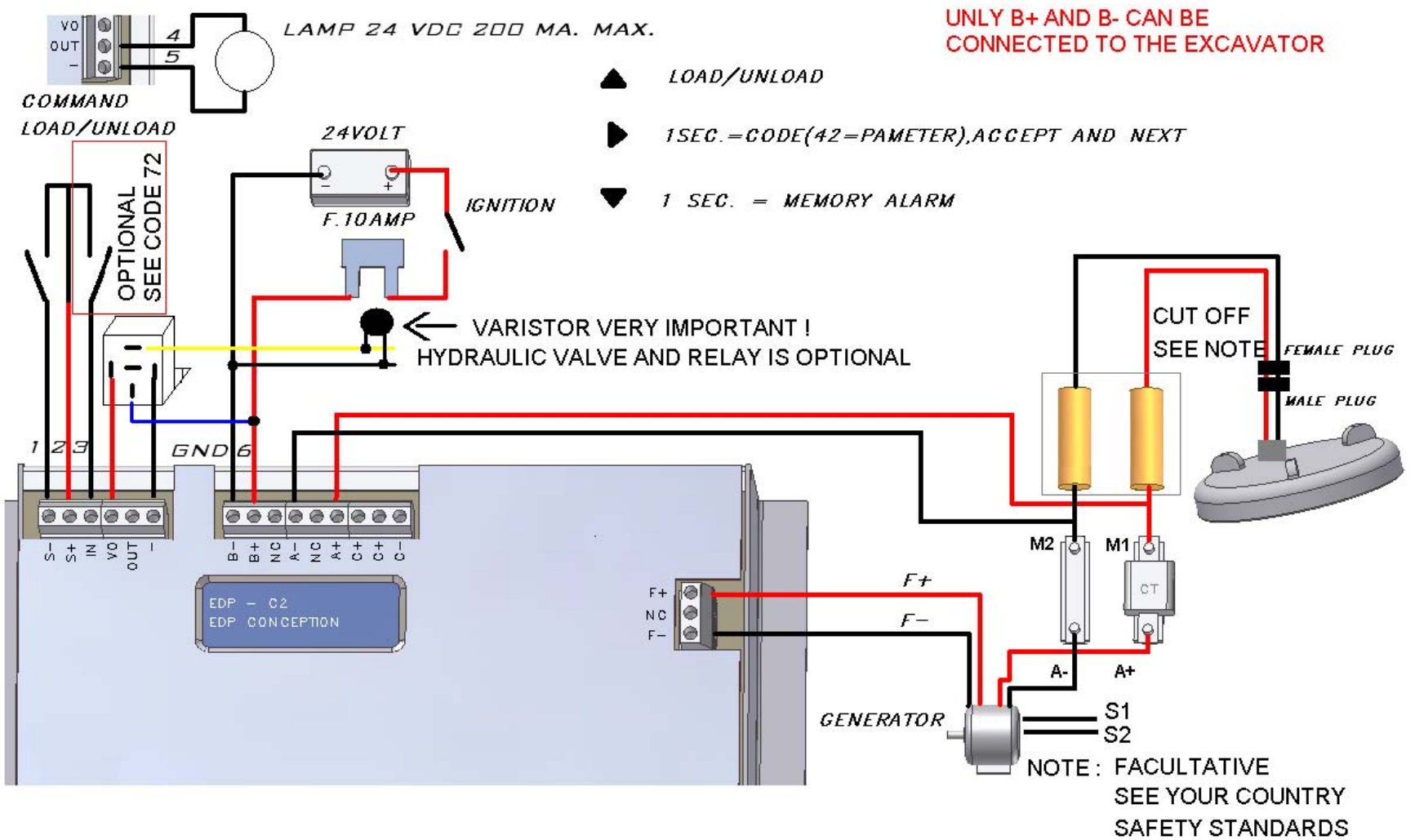

Programming

Hold the right arrow for a second. With the help of the arrows enter code 42 for the main parameters and code 72 for auxiliary input and output.

- Press on the right arrow.

Use the right arrow to scroll through the parameters.

- When you see the parameter you would like to adjust use the top and bottom arrows to change the value.
- Press on the right arrow; this will enter your changes.
- To exit the programming mode, press on the right arrow as many times as it takes to come back to the main menu.

Parameter description



And

The default values is in (..)

All the parameter who can affect unload can be test without accept

with right arrow 

- Language
Select language----- (English)
- High Tension
Tension in electromagnet
at time of high tension----- 220VDC to 300VDC (240VDC)

- T-High Tension
Time in which High Tension will be active----- 5 to 15 s (6s)
- Transport Tension
Tension in electromagnet
at time of Transport tension----- 180VDC to 240VDC (220VDC)
- Time out delay
Maximum charge time ----- 0 to 10 minute 0=infinity
(5 minute)
- Generator amperage (Electromagnet +15%)
Alarm amperage----- 15 to 200 amps (100 amps) *
- Field Voltage
Field tension----- 120v to 300v (250v)
- Dropping amps 
Amps of first dropping ----- 0 to 20 amps (0) *
Change in positive and negative to see the best dropping and set RATIO
- Ratio 1' dropping 
Power of first dropping sequence ----- 1 to 10/10 (5)
Change in positive and negative to see the best dropping .

* This parameter will chage with autoajustement

INPUT/OUTPUT (CODE 72)

- TB SW- MODE
 - TWIN + BOOST First short puls made load all other short pulse restart hight volt time and a long pulse made a dropping cycle.
 - TWIN - BOOST First short puls made load and a long pulse made a dropping cycle.
 - PULS First short puls made load and a next pulse made a dropping cycle.

DEFAULT IS TWIN + BOOST
- TB IN MODE
 - NIL set one button mude.
 - DROPING NC drop when open.
 - DROPING NO drop when close.
 - (NO) is more safe than (NF).

DEFAULT IS NIL

- **TB OUT MODE**
 - HYDRAULIC VALVE output go on at load mode
With a minimum time between 0 to 255 seconds.
 - MESSAGE ON DISPLAY output flash if an message appears on display
With an interval between 0 to 255 seconds.
 - TIME OUT. output flash if time out is reached
with an interval between 0 to 255 seconds.
 - LOAD UNLOAD output go on /off with load an unload.
 - TWIN like load unload plus flash if an message appears on display
With an interval between 0 to 255 seconds
message est affiché avec un intervalle de 0 a 255 secondes.
VALEUR D'ORIGINE EST DOUBLE
- **TEMPS TB VO**
 - VALVE HYDRAULIQUE sortie active a la magnétisation
avec un délais minimum de 0 a 255 secondes.
VALEUR D'ORIGINE 30 SECONDES

To put parameters back to default values

Press one second on the right arrow.

With the help of the arrows enter 0 and then press once on the right arrow.

Fuse Replacement

NOTE B : 1

- FUSE NO.1** MDL 2AMP
- FUSE NO.2** MDL 5AMP FOR A 36 VOLT SYSTEME
- FUSE NO.3** CERAMIC MDA 5AMP 250V
- FUSE NO.4** CERAMIC MDA 5AMP 250V

FIELD REVERSING SHUNT MOTOR

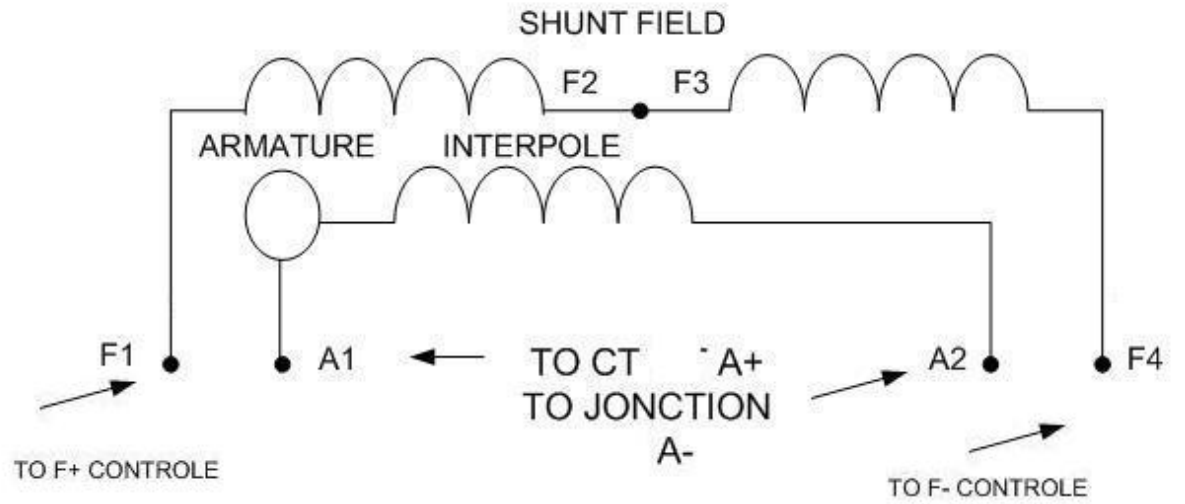

DC GENERATOR CONNECTION DIAGRAM COMPOUND WOUND SHORT CONNECTION

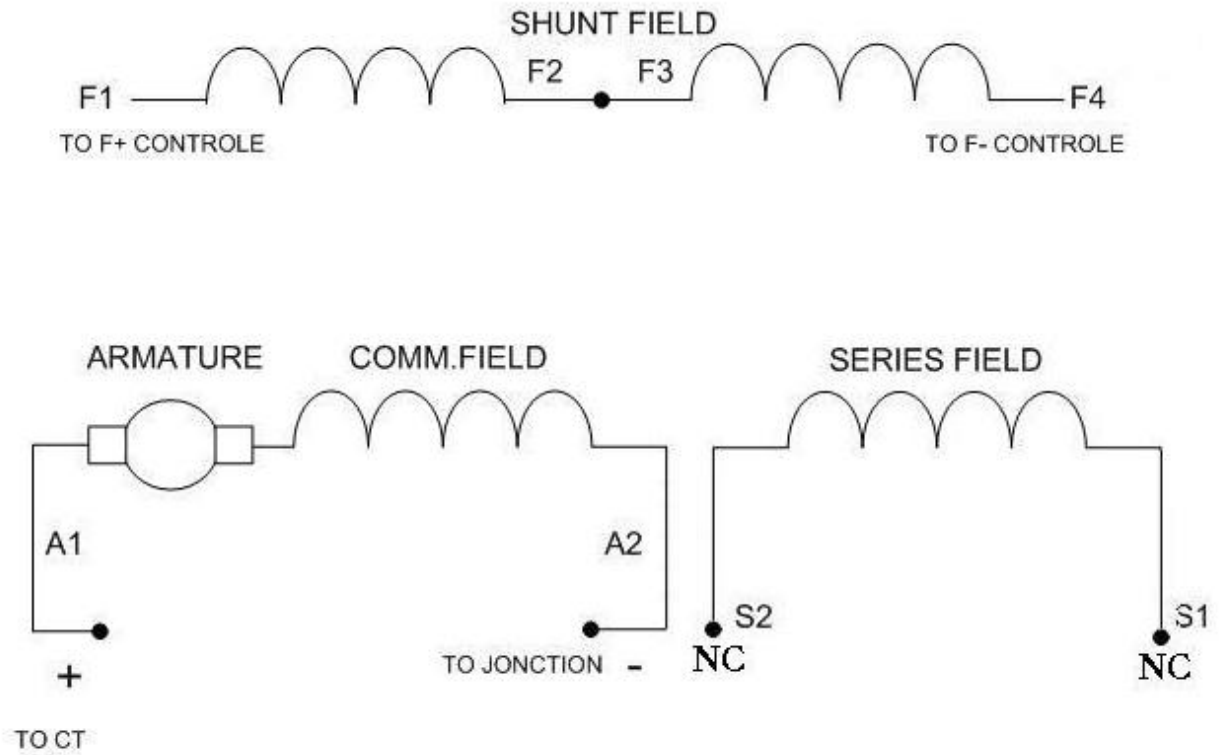

Conductor Size and Fuse Notification

The power conductors must be of proper size to resist the load. Use following table for conductor size:

<u>AMP</u>	<u>AWG</u>	<u>IEC</u>
0-20	12	4mm
20-30	10	6mm
30-45	8	10mm
45-75	6	16mm
76-125	4	25mm

Important Notice

The two power fuses D type are critical and must be well calibrated in regard to the generator used.

Pulley Size for maximum power

**The RPM must be 10% faster than the spec on generator
To reach 250 volt at the output .**

New Installations

- **1800 rpm generators 180 vdc field**
Power pulley diameter/1980 RPM X (Max motor RPM)
Equal generator pulley . $D/1980 \times \text{RPM}$
- **2500 rpm generators 230 vdc field**
Power pulley diameter/2750 RPM X (Max motor RPM)
Equal generator pulley . $D/2750 \times \text{RPM}$
- **3450 rpm generator 180 or 230 vdc field**
Power pulley diameter/3800 rpm X (Max motor RPM)
Equal generator pulley . $D/3800 \times \text{RPM}$

Existing Installation

Note: Choose the easiest pulley to change.

- **Power pulley calculations**

RPM written on generator name plate + 10% / current RPM X diameter of the power pulley

- **Calculation of generator pulley**

Current RPM / RPM written on generator name plate + 10% X diameter of generator pulley

Note: The direction of the rotation has no importance.

Note: Use C type Belts (.625 inch)

Generator Power in KW	Number of Belts
10-15 KW	2
15-33 KW	3
33-35 KW	4

Memory Alarm Display

Up to 20 alarms are memorized. Pressing and holding the bottom arrow for 1 second will allow you to visualize all memorized alarms. Use the bottom arrow to visualize the oldest alarms and the upper arrow to visualize the most recent alarms.

When you are done close the menu by pressing on the right arrow and the bottom arrow to leave without erasing the alarms. Pressing on only the right arrow will erase all alarms.

MESSAGE

The digital indicator will display controller abnormalities as help indicators. However verify abnormality indications for proper cause.

List of possible abnormalities:

- "1.>WIRE DISCONNED" - Check magnet connection
- "1.> OR FUSE BLOW " - Check the tow power fuse
 - After this alarm the power off is requested for 30 second.
- "2.> OVER AMP " - check megnet isolation .
 - After this alarm the power off is requested for 30 second.
- "3.> BROKEN CT " - The current transformer is bad or diconnected .
- "4>RPM LOW " - The speed is to low check strap or mecanic problem .
- "4>BRUSHES " - The brushes is too short or is jamed in holder .
- "4.SHORT-CIRCUIT " - The wire can have been circuit .
- "5. ROTATEE F+ F-" - The direction of rotation is bad .
 - Swap F+ and F- to fix the problem .
- "6.>FIELD + 30% " - Normaly this message apears if RPM is to low and the voltage is good. In this case the field volt will to hi.
- "7.> TIME OUT " - The time out parameter is reached.
 - The controller will drop vol to 50 vdc to prevent overheat Of magnet.
- "8.> HIGHT VOLT" - Check if the magnet is connected .
 - After this alarm the power off is requested for 30 second..
- "9. ROTATE CT" - Swap the connection of the CT.
- "10. OVERHEAT" - The inside temp uf controller is to hi.
 - The controller will drop the output power and you can Still working. If the temp continious to go up ,the Controller waits an droping and cancel load mode And waits low temp.

Press on the right arrow to reset abnormality display to zero.

Trouble Shooting

Problems frequently encountered

Proper Voltage is not reached or
bad magnetisation or demagnetisation

Causes

- Slipping Belts
- Low RPM
- Bad Connection(s)
- Generator is too small
- Faulty Brushes
- Insufficient Voltage
- Electronic circuit Fuses.

The voltage is good but there is a lack
of amperage or the electromagnet does
not lift enough material.

- A bad connection
- and/or the resistance of
the electromagnet

The output voltage is unstable.

- Check if field volt is less than
125v Then the RPM is to low.

The demagnetisation is not constant

- verify the brushes
- insufficient RPM

Signalling Lamps and Description

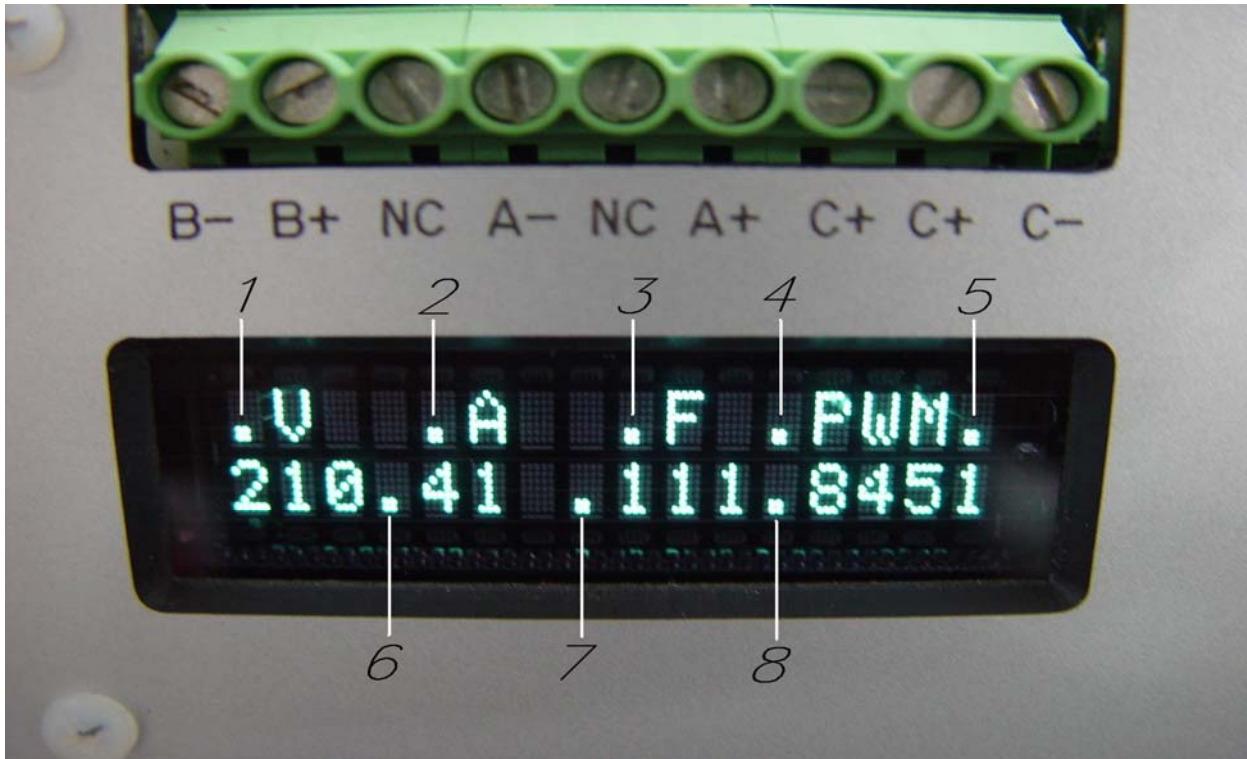

1-Manual Command

2-IGBT Positive

3-IGBT Negative

4-PWM Active

5-Cycle

6-Enter(IN)

7-V OUT

8-OUT

V=Positive armature voltage

v=Negative armature voltage

A=Positive Amperage

a=Negative Amperage

F=Field voltage Positive

f=Field voltage negative



EDP CONCEPTION PRODUCT WARRANTY

EDP Conception warrants that the EDP product you have purchased shall be free of any defects in parts and workmanship if used under normal operating conditions for a period of one (1) year from the date of purchase. This warranty shall run only to the original purchaser when purchased from an authorised EDP Dealer.

Defective products that qualify for coverage under this warranty will be repaired or replaced, at EDP's discretion with a like or comparable unit, without charge.

To receive warranty service, return the complete product to an authorised EDP Dealer service center. The EDP Dealer from whom you purchased your unit may also be authorised for warranty service and should be the first point of contact when service is required.

TRANSPORTATION COSTS ARE NOT INCLUDED IN THIS LIMITED WARRANTY.

Any repair or service performed by any person or entity other than an authorised EDP Service Center is not covered by this limited warranty. This limited warranty becomes void if the product has been damaged by alteration, misuse, accident, or neglect; or the product has been repaired or serviced by persons not authorised by EDP Conception.

EDP CONCEPTION ASSUMES NO LIABILITY FOR PROPERTY DAMAGE RESULTING FROM NEITHER FAILURE OF THIS PRODUCT NOR ANY LOSS OF INCOME, SATISFACTION, OR DAMAGE ARISING FROM THE LOSS OF USE OF SAME DUE TO DEFECTS OR AVAILABILITY OF SAME DURING SERVICE.

This warranty applies only to EDP Conception products purchased and serviced within Canada and the United States of America.

Service instructions:

Call your EDP authorised dealer to receive a Request for Service (RS) number before shipping. Be sure to check your entire system before shipping your unit. Units received that are in good working condition, will be returned with a service fee to cover inspection and return shipment.

EFFECTIVE DATE: SEPTEMBER 1, 2008

EDP CONCEPTION INC.
2883, TRUDEL BLVD EAST
ST-BONIFACE (QUEBEC) CANADA G0X 2L0
Phone: 819-535-6686 fax: 819-535-6247
info@edpconception.com
www.edpconception.com

Important Notice

Security Warning

The controller is only a portion of the electro mechanic lifting system and electromagnet therefore precautions must be taken around the system by the user to ensure the safety of all users and workers. In this type of system a bad wire, bad fuse, generator malfunction, or other may cause the load to suddenly drop and cause serious injuries and even death.

Note A:1

Important notice

A tension of 0 to 24 volts DC may be found at the exit of the controller when the generator is turning even if the manual command is not activated. This tension is due to the magnetic activity coming from the generator.

EDP-C2

Value Notification Table

Maximum value achieved during the first 4 seconds

V	A	F	PWM

Value achieved after 10 seconds

V	A	F	PWM

Generator			
Manufacture			
Model			
Armature Voltage		AMP	<i>KW</i>
Field Voltage		AMP	

Electromagnet	
Manufacture	
Model	
Volt	
AMP	
Diameter	